

# Reconnecting an IQ Gateway or Envoy S to Wi-Fi

## using the Enphase App

If you have changed your internet service provider, Wi-Fi network password, or Wi-Fi network name, follow these steps to reconnect your gateway to the internet. Ensure that you are in proximity to the gateway throughout the process.

1. Open the Enphase App. Navigate to **Menu > Settings > Connectivity** and tap **Configure Wi-Fi**.

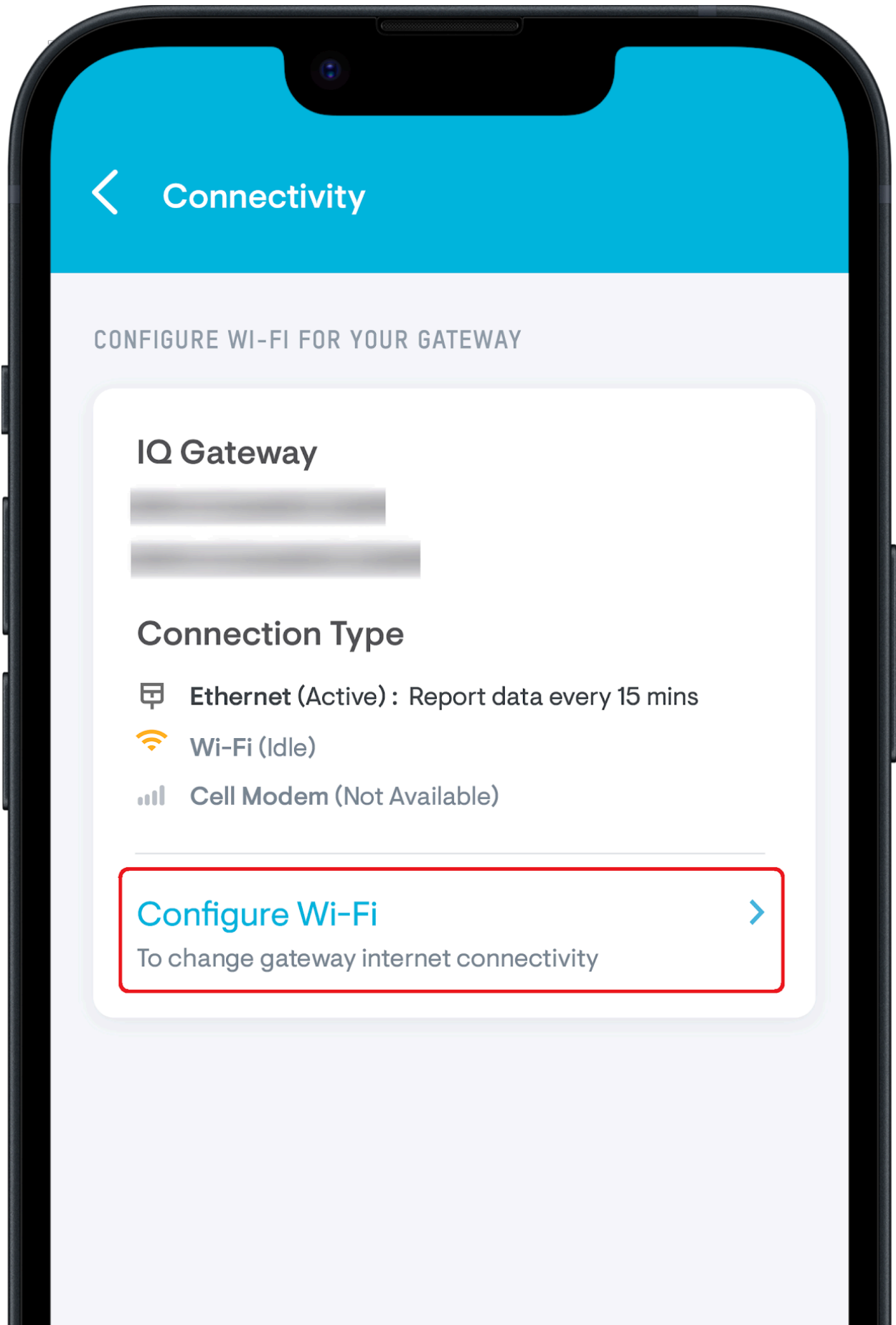



1/5 Sunset Avenue  
Barrack Heights | NSW | 2528  
(02) 4257 0974  
info@sunpeople.com.au  
www.sunpeople.com.au

2. Tap the **Connect** button, and then tap **Join** in the prompt that appears. This connects your mobile device to the gateway.

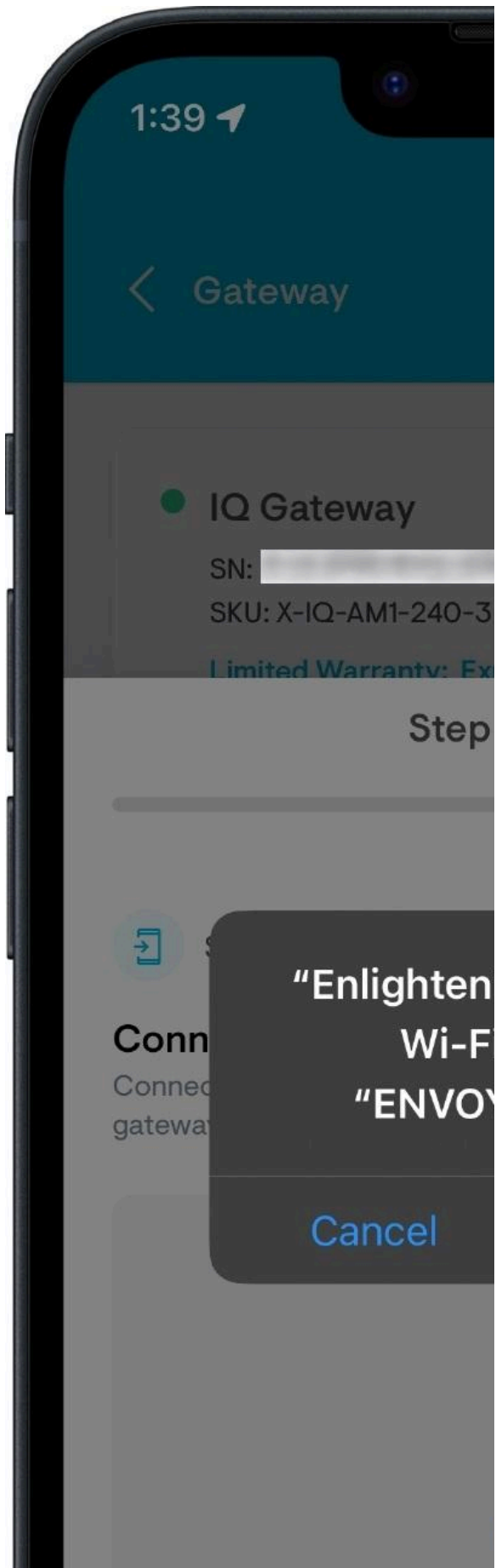
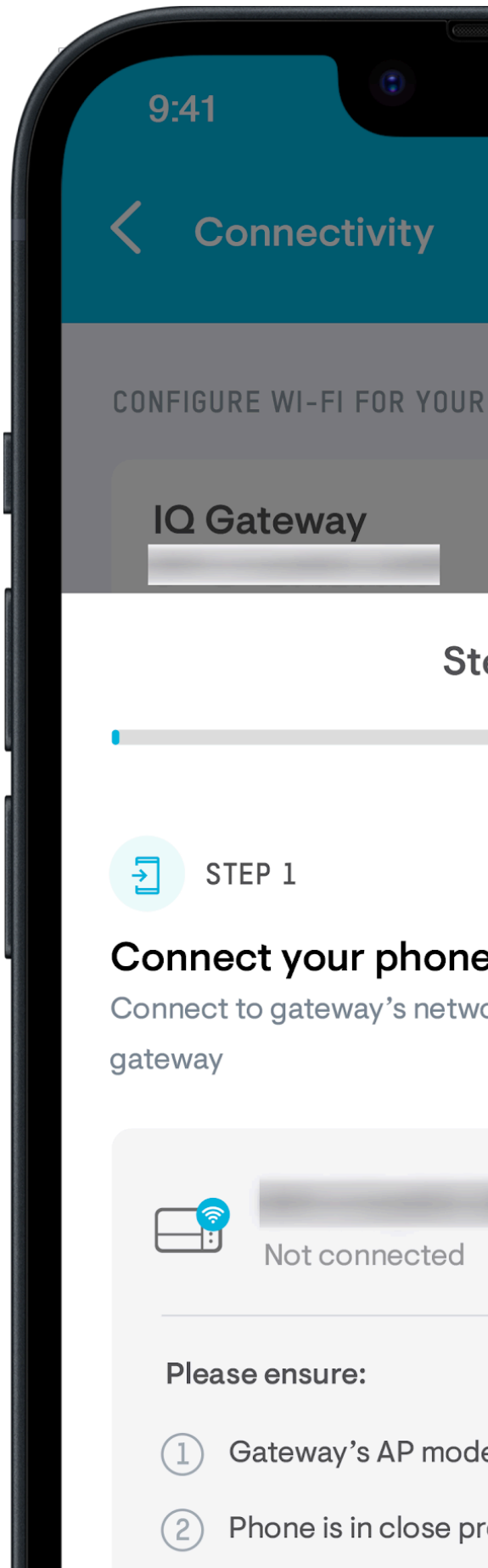



1/5 Sunset Avenue  
Barrack Heights | NSW | 2528  
(02) 4257 0974  
info@sunpeople.com.au  
www.sunpeople.com.au

**Note:** If you are unable to connect your mobile device to the gateway, tap the **Retry** button once the AP mode is turned on.

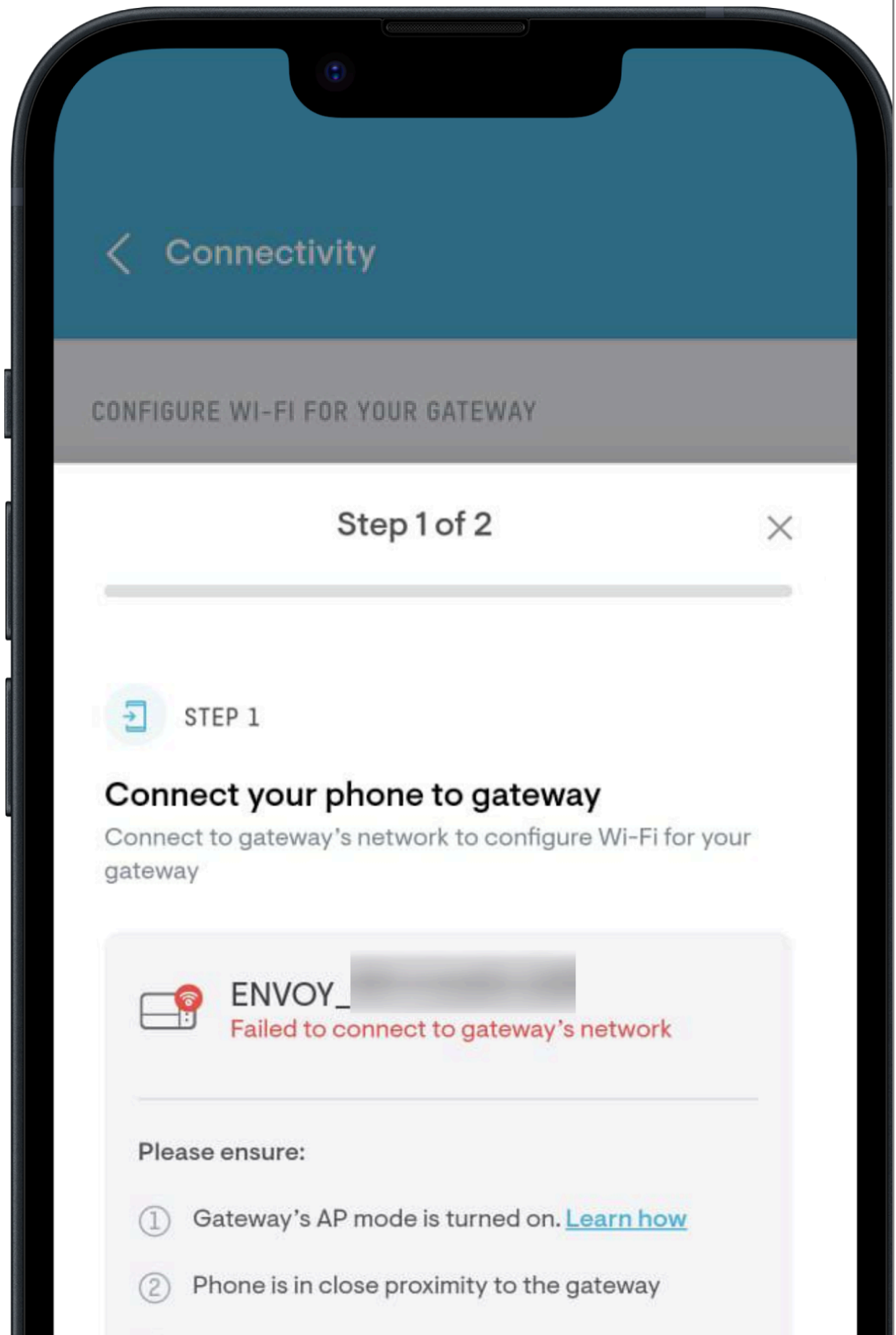

To turn on AP mode, press the AP mode button on **the gateway**. Do not long press. The AP mode LED turns green once AP mode is enabled.

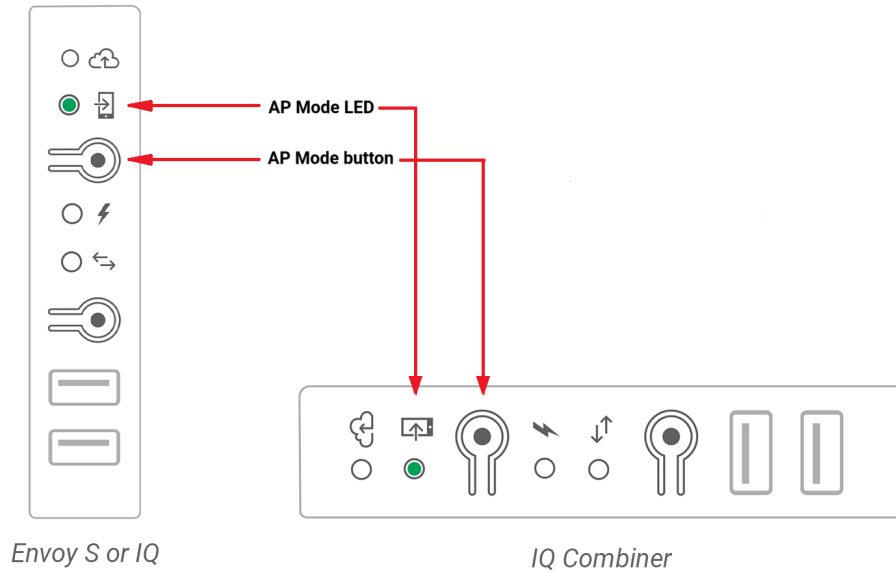

3. Tap **Scan Wi-Fi Network** to see a list of the Wi-Fi networks available near you.

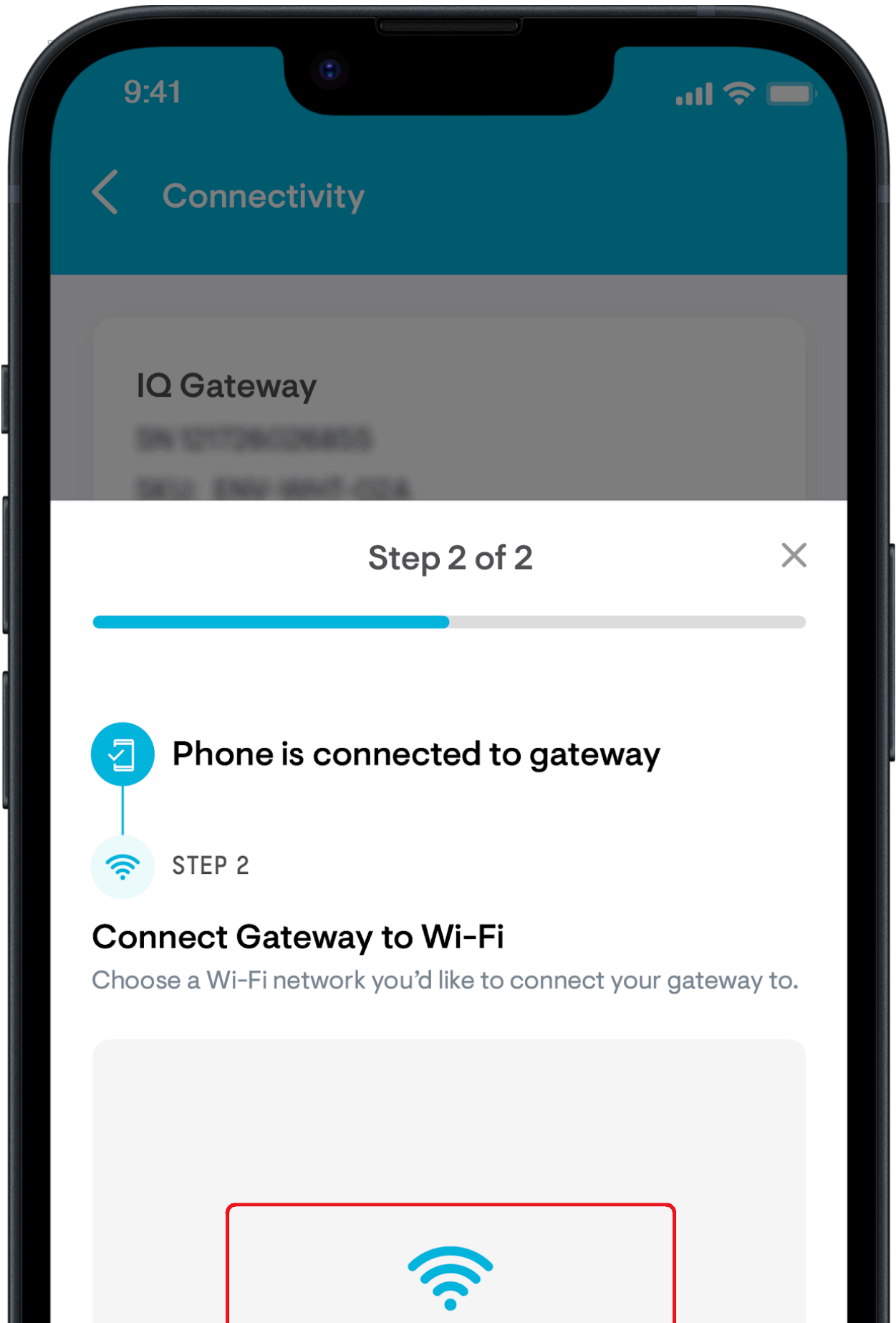



1/5 Sunset Avenue  
Barrack Heights | NSW | 2528  
(02) 4257 0974  
[info@sunpeople.com.au](mailto:info@sunpeople.com.au)  
[www.sunpeople.com.au](http://www.sunpeople.com.au)

4. Tap the Wi-Fi network you want the gateway to connect to.

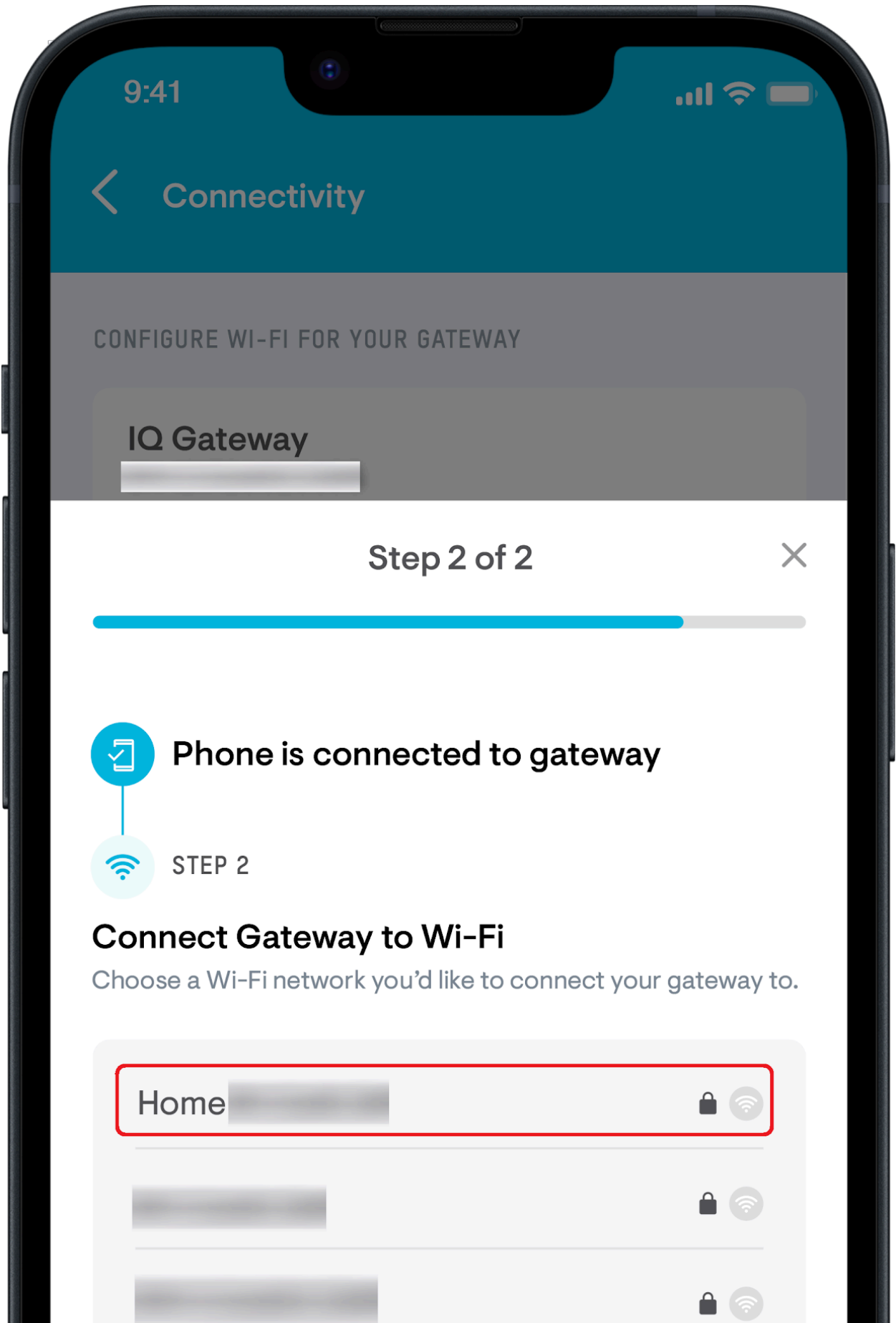



1/5 Sunset Avenue  
Barrack Heights | NSW | 2528  
(02) 4257 0974  
info@sunpeople.com.au  
www.sunpeople.com.au

5. Enter the Wi-Fi network password and tap the **Join** button to connect your gateway to the internet.

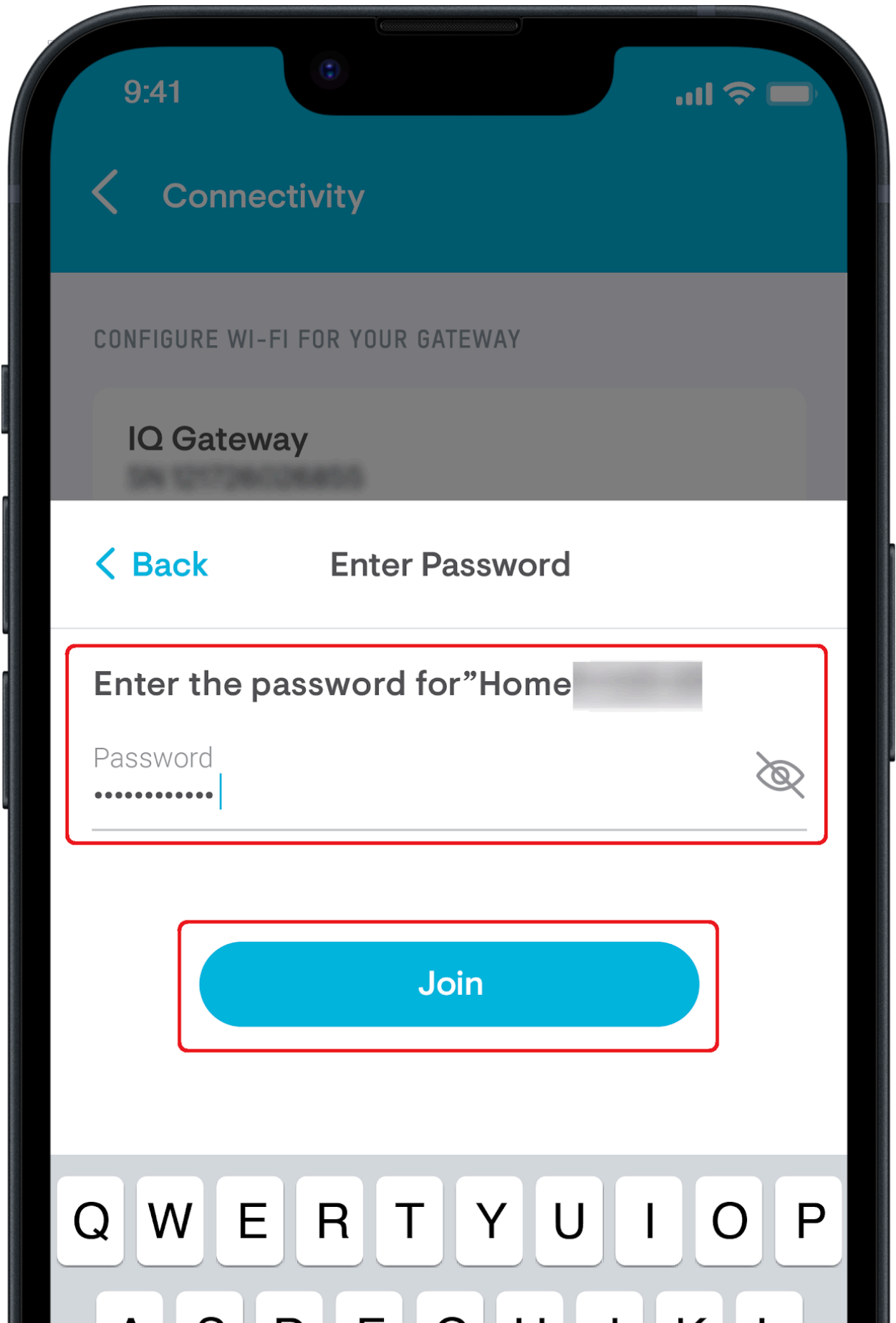



1/5 Sunset Avenue  
Barrack Heights | NSW | 2528  
(02) 4257 0974  
info@sunpeople.com.au  
www.sunpeople.com.au

6. The Enphase App will inform you once the gateway has successfully connected to the Wi-Fi network.

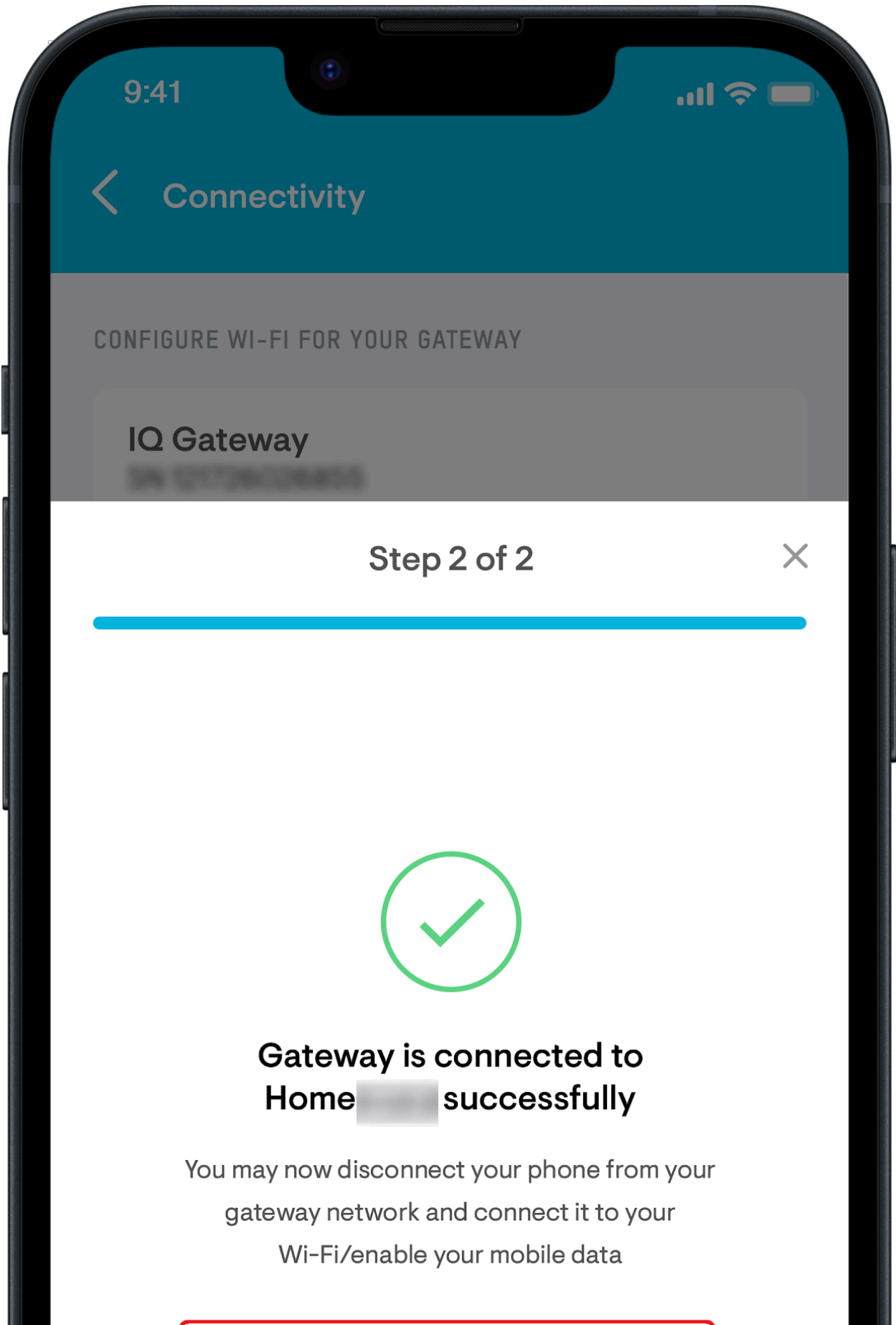



1/5 Sunset Avenue  
Barrack Heights | NSW | 2528  
(02) 4257 0974  
info@sunpeople.com.au  
www.sunpeople.com.au

**Note:** After the gateway reconnects, it will require approximately an hour to synchronize the energy data for each day the gateway was offline. For example, if your gateway was offline for 30 days, your system should fully sync up in about 30 hours.

If you are still unable to connect the gateway to your home Wi-Fi, try [connecting it manually](#).

TAKEN FROM ENPHASE;

<https://support.enphase.com/s/article/reconnecting-an-iq-gateway-or-envoy-s-to-wi-fi-using-the-enphase-app> - VIDEO GUIDE